

* 1/4" THICK STRIKER PLATES INSTALLED ON THE TANK INTERIOR BOTTOM UNDER EACH OPENING IN ACCORDANCE WITH STEEL TANK INSTITUTE
 * ALL OPENINGS INSTALLED WITH DI-ELECTRIC BUSHINGS OR SPOOL FLANGES AND FLANGE ISOLATION KITS IN ACCORDANCE WITH STEEL TANK INSTITUTE
 **** THIS TANK DESIGNED FOR MAXIMUM BURIAL DEPTH OF 5 FEET (GRADE TO TOP OF TANK) WITH APPROVED BACKFILL MATERIAL ****

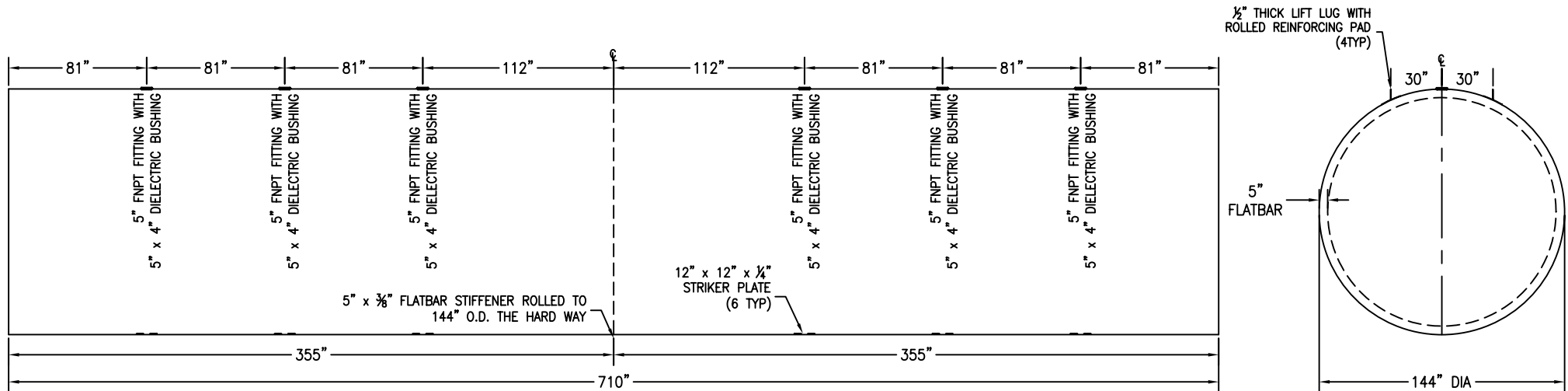

LIFT LUGS OFFSET
 30" FROM CENTERLINE



CUSTOMER APPROVAL SIGNATURE/DATE:

50,000 GALLON ACT 100 S/W UNDER GROUND TANK

SURFACE PREPARATION/COATING INFORMATION:
 INTERIOR SURFACES: N/A
 EXTERIOR SURFACES: SSPC-SP-6 COMMERCIAL BLAST CLEAN
 100 mils MINIMUM STEEL TANK INSTITUTE APPROVED FIBERGLASS
 REINFORCED POLYESTER RESIN COATING (REICHOLD CHEMICALS
 33-402/33-404 POLYESTER RESIN AND PPG FIBERGLASS ROVING)

MATERIAL /CONSTRUCTION/ LABELING INFORMATION:
 MATERIAL: CARBON STEEL (ASTM A 36, ASTM A 635 OR ASTM A 569)
 MATERIAL THICKNESS: PRIMARY TANK: 3/8" (ROARK MINIMUM .3315 w/STIFFNER)
 PRIMARY HEADS: 5/16"
 CONSTRUCTION IN ACCORDANCE WITH UNDERWRITERS LABORATORIES UL-58 STANDARD FOR
 STEEL UNDERGROUND TANKS FOR FLAMMABLE AND COMBUSTIBLE LIQUIDS AND STEEL TANK
 INSTITUTE ACT-100 SPECIFICATION FOR EXTERNAL CORROSION PROTECTION OF FRP COMPOSITE
 STEEL UNDERGROUND STORAGE TANKS
 LABELING/MARKING: UNDERWRITERS LABORATORIES UL-58
 / STEEL TANK INSTITUTE ACT-100 / G.I. NAMEPLATE

CUSTOMER:
 PROJECT:
 AGENT:

P.O. BOX 1279 GOLDSBORO, NC 27533
 PHONE: (919)751-1791 FAX: (919)751-8186
 DRAWING NUMBER:

QUANTITY: ONE (1) REQUIRED
 WEIGHT: 42,000 lbs ± 5%